

Solenoid directional valves P_{max} 420 bar

direct operated, ISO 4401 size 06 and size 10

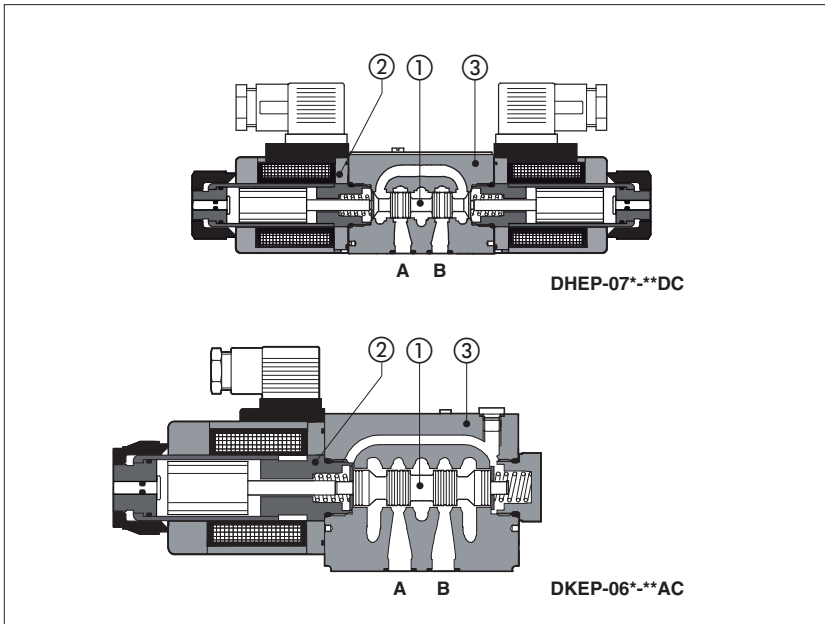

DHEP; DKEP

Spool type, direct operated solenoid valves with max pressure up to 420 bar for heavy duty applications.

They are equipped with threaded solenoids certified according the North American standard **cUus**

Single and double solenoid valves are available in two or three position configurations and with a wide range of interchangeable spools ①, see section ②.

Solenoids ② are made by:

- wet type screwed tube, different for AC and DC power supply, with integrated manual override pin c
- interchangeable coils, specific for AC or DC power supply, easily replaceable without tools - see section 5 for available voltages

Standard coils protection IP65 (once correctly assembled with relevant electric connectors).

The valve body ③ is made by high strength cast iron.

Mounting surface ISO 4401 size **06** and **10**

Max flow up to **80** and **150** l/min

Max pressure: **420** bar

1 MODEL CODE

DHEP - 0	63	1/2	/A	X	24 DC	**	/*
Directional control valves DHEP-0 = Size 06 DKEP-1 = Size 10							Seals material, see sect. ③, ④: - = NBR PE = FKM BT = HNBR
Valve configuration, see table ② 61 = single solenoid, center plus external position, spring centered 63 = single solenoid, 2 external positions, spring offset 67 = single solenoid, center plus external position, spring offset 71 = double solenoid, 3 positions, spring centered 75 = double solenoid, 2 external positions, with detent							Series number _____
Spool type, see table ②.							Voltage code, see section ④
Options, see note 1 at section ⑤				00-AC = AC solenoids without coils 00-DC = DC solenoids without coils X = without connector See note 2 at section ⑤ for available connectors, to be ordered separately Coils with special connectors, see section ⑦ XJ = AMP Junior Timer connector XK = Deutsch connector XS = Lead Wire connection			

2 CONFIGURATIONS and SPOOLS

Configurations	Spools	Configurations	Spools
<p>61</p> <p>61/A</p> <p>67</p> <p>67/A</p> <p>71</p>	<p>0</p> <p>1</p> <p>2</p> <p>3</p> <p>4</p> <p>5</p> <p>6</p> <p>7</p> <p>8</p> <p>90</p> <p>09</p> <p>91</p> <p>19</p> <p>93</p> <p>39</p> <p>94</p> <p>49</p> <p>16</p> <p>17</p> <p>58</p> <p>1/9</p> <p>only for DHEP</p> <p>only for DHEP</p> <p>only for DHEP</p> <p>only for DHEP</p> <p>only for DHEP</p> <p>only for DHEP</p> <p>only for DHEP</p> <p>only for DHEP</p> <p>only for DHEP</p> <p>only for DHEP</p> <p>only for configuration 71</p>	<p>63</p> <p>63/A</p> <p>75</p>	<p>0/2</p> <p>1/2</p> <p>2/2</p>

3 MAIN CHARACTERISTICS OF DHE* DIRECTIONAL VALVES

Assembly position / location	Any position
Subplate surface finishing	Roughness index Ra 0,4 - flatness ratio 0,01/100 (ISO 1101)
MTTFd values according to EN ISO 13849	300 years, for further details see technical table P007
Ambient temperature	from -30°C to +70°C (standard seals) -20°C to +70°C (/PE seals) -40°C to +60°C (/BT seals)
Flow direction	As shown in the symbols of section 2
Operating pressure	Ports P,A,B: 420 bar; Port T 210 bar for DC version; 160 bar for AC version
Rated flow	See diagrams Q/Δp at section 8, 12
Maximum flow	DHEP 80 l/min, DKEP 150 l/min , see operating limits at section 9, 13

3.1 Coils characteristics

Insulation class	H (180°C) for DC coils F (155°C) for AC coils Due to the occurring surface temperatures of the solenoid coils, the European standards EN ISO 13732-1 and EN ISO 4413 must be taken into account
Protection degree to DIN EN 60529	IP 65 (with connectors 666, 667, 669 or E-SD correctly assembled)
Relative duty factor	100%
Supply voltage and frequency	See electric feature 5
Supply voltage tolerance	± 10%
Certification	cURus North American Standard

4 SEALS AND HYDRAULIC FLUID

Seals, recommended temperature fluid	NBR seals = -20°C ÷ +60°C, with HFC hydraulic fluids = -20°C ÷ +50°C FKM seals = -20°C ÷ +80°C HNBR seals = -40°C ÷ +60°C, with HFC hydraulic fluids = -40°C ÷ +50°C		
Recommended viscosity	20 ÷ 100 mm ² /s - max allowed range 15 ÷ 380 mm ² /s		
Fluid contamination class	ISO 4406 class 20/18/15 NAS 1638 class 9, in line filters of 10 μm (β10 ≥75 recommended)		
Hydraulic fluid	Suitable seals type	Classification	Ref. Standard
Mineral oils	NBR, FKM, HNBR	HL, HLP, HLPD, HVLP, HVLPD	DIN 51524
Flame resistant without water	FKM	HFDU, HFDR	ISO 12922
Flame resistant with water	NBR, HNBR	HFC	

Note: For other fluids not included in above table, consult our technical office

5 NOTES FOR DHEP AND DKEP

1 Options

- A** = Solenoid mounted at side of port B (only for single solenoid valves). In standard versions, solenoid is mounted at side of port A.
WP = prolonged manual override protected by rubber cap.

⚠ The manual override operation can be possible only if the pressure at T port is lower than 50 bar.

WPD/HE-DC = (only for DHEP-DC) manual override with detent, to be ordered separately, see tab. K150

WPD/KE-DC = (only for DKEP-DC) manual override with detent, to be ordered separately, see tab. K150

2 Type of electric/electronic connector DIN 43650, to be ordered separately

- 666** = standard connector IP-65, suitable for direct connection to electric supply source.
667 = as 666, but with built-in signal led.
669 = with built-in rectifier bridge for supplying DC coils by alternate current (AC 110V and 230V - I_{max} 1A).
E-SD = (only for DHEP) electronic connector which eliminates electric disturbances when solenoid valves are de-energized.

3 Spools for DHEP

- spools type **0** and **3** are also available as **0/1** and **3/1** with restricted oil passages in central position, from user ports to tank.
- spools type **1, 4, 5** and **58** are also available as **1/1, 4/8, 5/1** and **58/1**. They are properly shaped to reduce water-hammer shocks during the switching.
- spools type **1, 1/2, 3, 8** are available as **1P, 1/2P, 3P, 8P** to limit valve internal leakages.
- Other types of spools can be supplied on request.

Spools for DKEP

- spools type **0** and **3** are also available as **0/1** and **3/1** with restricted oil passages in central position, from user ports to tank.
- spools type **1** is also available as **1/1**, properly shaped to reduce the water-hammer shocks during the switching.
- spool type **1/9** has closed center in rest position but it avoids the pressurization of A and B ports due to the internal leakages.
- other types of spools can be supplied on request.

6 ELECTRIC FEATURES

External supply nominal voltage ± 10%	Voltage code	Type of connector	Power consumption (2)	Code of spare coil	
				DHEP	DKEP
12 DC	12 DC	666 or 667	30 W (DHEP) 36 W (DKEP)	COE-12DC	CAE-12DC
14 DC	14 DC			COE-14DC	CAE-14DC
24 DC	24 DC			COE-24DC	CAE-24DC
28 DC	28 DC			COE-28DC	CAE-28DC
110 DC	110 DC			COE-110DC	CAE-110DC
125 DC	125 DC			COE-125DC	-
220 DC	220 DC			COE-220DC	CAE-220DC
110/50/60 AC	110/50/60 AC	669	58 VA (DHEP) 85 VA (DKEP) (3)	COE-110/50/60AC (1)	CAE-110/50/60AC (1)
230/50/60 AC	230/50/60 AC			COE-230/50/60AC (1)	CAE-230/50/60AC (1)
115/60 AC	115/60 AC			COE-115/60AC	CAE-115/60AC
230/60 AC	230/60 AC			COE-230/60AC	CAE-230/60AC
110/50/60 AC	110 RC	669	30 W (DHEP) 36 W (DKEP)	COE-110DC	CAE-110DC
230/50/60 AC	220 RC			COE-220DC	CAE-220DC
110/50/60 AC	110 DC			COE-110DC	CAE-110DC
230/50/60 AC	220 DC			COE-220DC	CAE-220DC

- (1) In case of 60 Hz voltage frequency the performances are reduced by 10÷15% and the power consumption is 80 VA for DHEP and 90 VA for DKEP.
- (2) Average values based on tests performed at nominal hydraulic condition and ambient/coil temperature of 20°C.
- (3) When solenoid is energized, the inrush current is approx 3 times the holding current. Inrush current values correspond to a power consumption of about 280 VA for DHEP and 320 VA for DKEP.

7 COIL WITH SPECIAL CONNECTORS only for voltage supply 12, 14, 24, 28 Vdc

COIL COE for DHEP

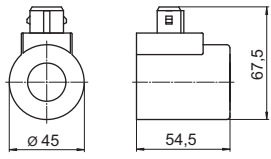
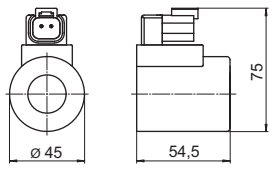
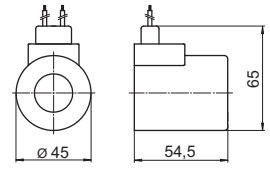
AMP Junior timer connector	Deutsch connector DT-04-2P	Lead Wire connection
 <p>Options -XJ, coil type COEJ AMP Junior Timer connector Protection degree IP67</p>	 <p>Options -XK, coil type COEK Deutsch connector, DT-04-2P male Protection degree IP67</p>	 <p>Options -XS, coil type COES Lead Wire connection Cable length = 180 mm</p>

COIL CAE for DKEP

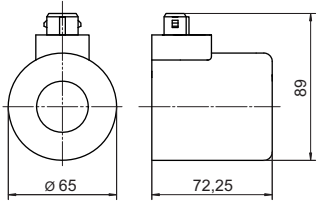
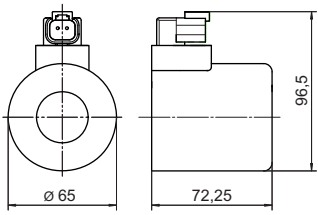
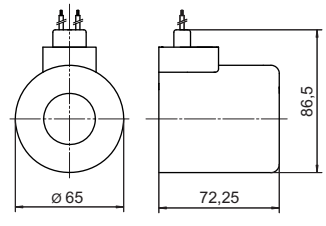
AMP Junior timer connector	Deutsch connector DT-04-2P	Lead Wire connection
 <p>Options -XJ Coil type CAEJ AMP Junior Timer connector Protection degree IP67</p>	 <p>Options -XK Coil type CAEK Deutsch connector DT-04-2P male Protection degree IP67</p>	 <p>Options -XS Coil type CAES Lead Wire connection Cable length = 180 mm</p>

Note: for the electric characteristics refer to standard coils features - see section 6

8 Q/ΔP DIAGRAMS based on mineral oil ISO VG 46 at 50°C

Flow direction Spool type	Flow direction				
	P→A	P→B	A→T	B→T	P→T
0, 0/1	A	A	C	C	D
1, 1/1	D	C	C	C	
3, 3/1	D	D	A	A	
4, 4/8, 5, 5/1, 58, 58/1 09, 90, 91, 93, 94	F	F	G	C	E
1/2, 0/2	D	D	D	D	
6, 7	D	D	D	D	
8	A	A	E	E	
2	D	D			
2/2	F	F			

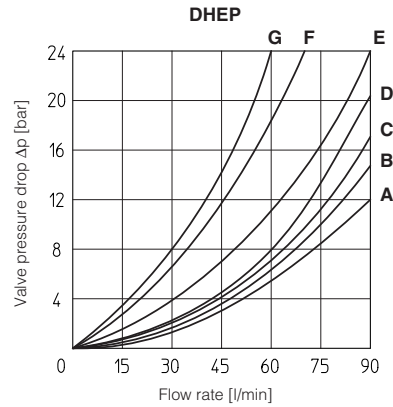

9 OPERATING LIMITS based on mineral oil ISO VG 46 at 50°C

The diagrams have been obtained with warm solenoids and power supply at lowest value ($V_{nom} - 10\%$). The curves refer to application with symmetrical flow through the valve (i.e. P→A and B→T). In case of asymmetric flow and if the valves have the devices for controlling the switching times the operating limits must be reduced.

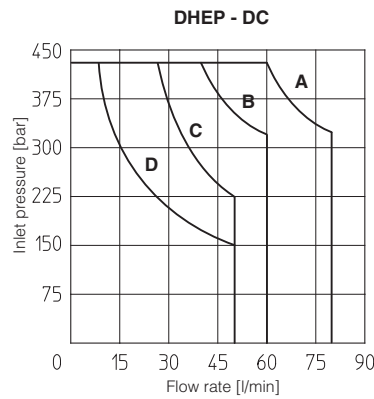
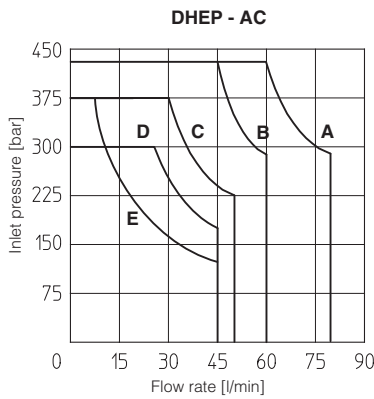

Curve	Spool type	
	AC	DC
A	1, 1/2, 8	0, 0/1, 1, 1/2, 3, 8
B	0, 0/1, 0/2, 1/1	0/2, 1/1, 6, 7
C	3, 3/1	3/1, 4, 4/8, 5, 5/1, 19, 39, 58, 90, 91, 93, 94
D	4, 4/8, 5, 5/1, 6, 7, 19, 39, 58, 91, 93, 94	2, 2/2
E	2, 2/2	-

10 SWITCHING TIMES (average values in msec)

Valve	Switch-on AC	Switch-off AC	Switch-on DC	Switch-off DC
DHEP	10 - 25	20 - 40	30 - 50	15 - 25

Test conditions:

- 36 l/min; 150 bar
- nominal voltage
- 2 bar of counter pressure on port T
- mineral oil: ISO VG 46 at 50°C.

The elasticity of the hydraulic circuit and the variations of the hydraulic characteristics and temperature affect the response time.

11 SWITCHING FREQUENCY

Valve	AC (cycles/h)	DC (cycles/h)
DHEP + 666 / 667	7200	15000

12 Q/ΔP DIAGRAMS based on mineral oil ISO VG 46 at 50°C

Flow direction Spool type	Flow direction					
	P→A	P→B	A→T	B→T	P→T	B→A
0, 0/1, 0/2, 2/2	A	A	B	B		
1, 1/1, 1/3, 6, 8	A	A	D	C		
3, 3/1, 7	A	A	C	D		
4	B	B	B	B	F	
5	A	B	C	C	G	
1/2	B	C	C	B		
2/7	D			F		
5/7	B			A	E	
19	A	D	C			H

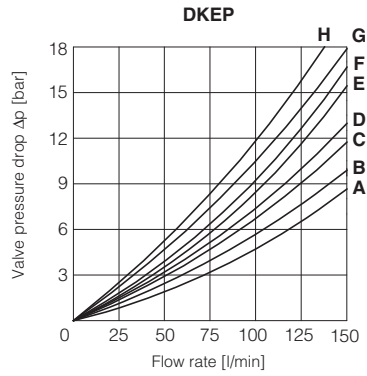

13 OPERATING LIMITS based on mineral oil ISO VG 46 at 50°C

The diagrams have been obtained with warm solenoids and power supply at lowest value ($V_{nom} - 10\%$). The curves refer to application with symmetrical flow through the valve (i.e. P→A and B→T). In case of asymmetric flow and if the valves have the devices for controlling the switching times the operating limits must be reduced.

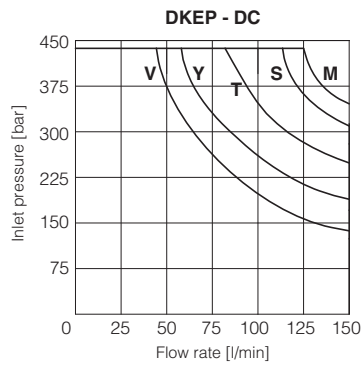
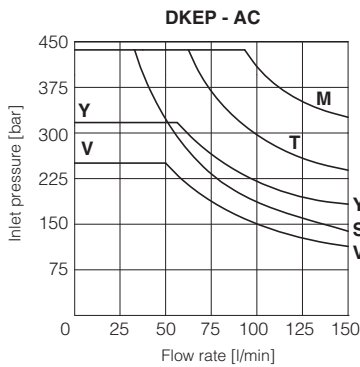

Curve	Spool type	
	AC	DC
M	0/1, 5/7, 1/3	0, 0/1, 1, 1/1, 3, 3/1, 1/2, 0/2, 8
S	2/7, 4, 5, 19	1/3, 5/7, 6, 7
Y	1, 1/2, 0/2	4, 5, 2/7
V	6, 7, 8, 2/2	2/2
T	0, 1/1, 3, 3/1	19
U	-	4, 5
Z	-	0/1, 1/1, 3/1

14 SWITCHING TIMES (average values in msec)

Valve	Switch-on AC	Switch-on DC	Switch-off AC	Switch-off DC
DKEP + 666 / 667	40	60	25	35

Test conditions:

- 50 l/min; 150 bar
- nominal supply voltage
- 2 bar of back pressure on port T
- mineral oil ISO VG 46 at 50°C

The elasticity of the hydraulic circuit and the variations of the hydraulic characteristics and temperature affect the response time.

15 SWITCHING FREQUENCY

Valve	AC (cycles/h)	DC (cycles/h)
DKEP + 666 / 667	7200	15000

ISO 4401: 2005

Mounting surface: 4401-03-02-0-05

Fastening bolts: 4 socket head screws:
 M5x30 class 12.9
 Tightening torque = 8 Nm
 Seals: 4 OR 108
 Ports P,A,B,T: $\varnothing = 7.5$ mm (max)

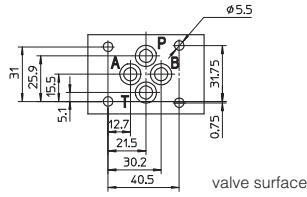

P = PRESSURE PORT
A, B = USE PORT
T = TANK PORT

DHEP-06(DC)

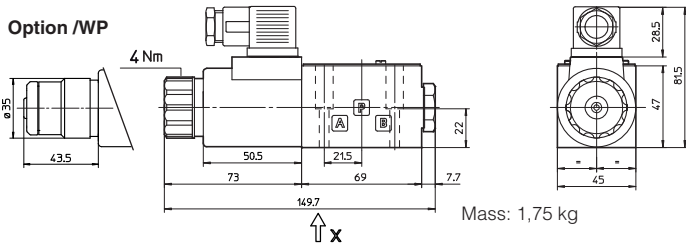

Mass: 1,75 kg

DHEP-07(DC)

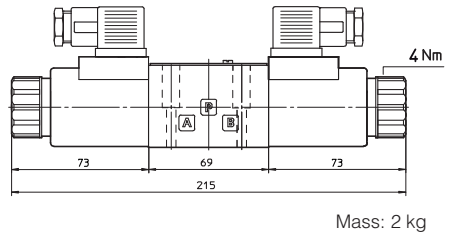

Mass: 2 kg

DHEP-06(AC)

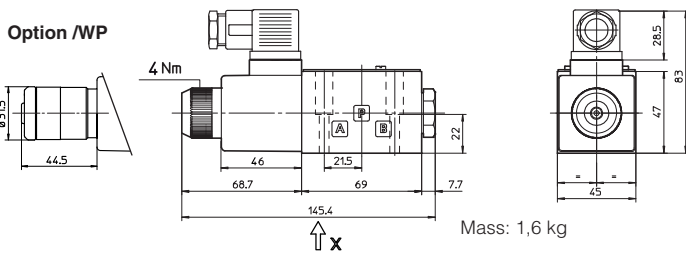

Mass: 1,6 kg

DHEP-07(AC)

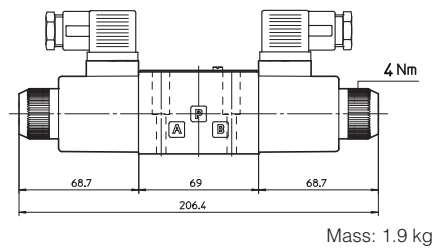

Mass: 1,9 kg

ISO 4401: 2005

Mounting surface according to 4401-05-05-0-05 (without X port, Y port optional)

Fastening bolts:
 4 socket head screws M6x40 class 12.9
 Tightening torque = 15 Nm
 Seals: 5 OR 2050 and 1 OR 108
 Ports P,A,B,T: $\varnothing = 11.5$ mm (max)
 Ports Y: $\varnothing = 5$ mm

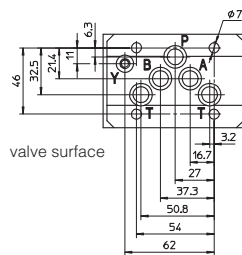

P = PRESSURE PORT
A, B = USE PORT
T = TANK PORT
Y = DRAIN PORT (only for option /Y)
 For the max pressures on ports, see section 3

DKEP-16*-DC

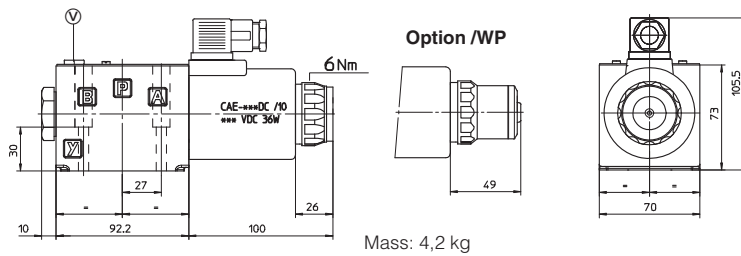

Mass: 4,2 kg

DKEP-17*-DC

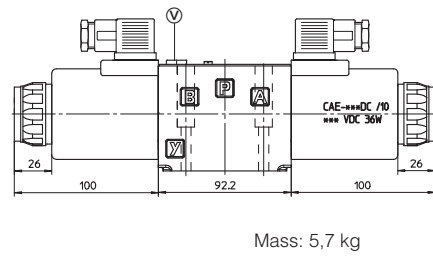

Mass: 5,7 kg

DKEP-16*-AC

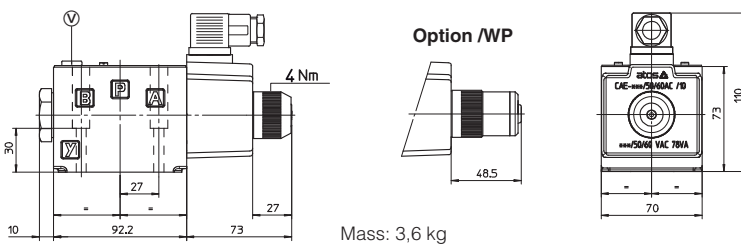

Mass: 3,6 kg

DKEP-17*-AC

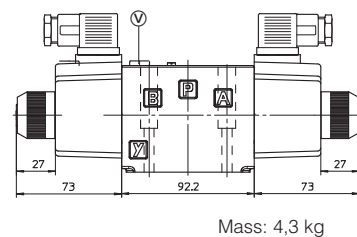

Mass: 4,3 kg

Overall dimensions refer to valves with connectors type 666